

BCZ8060-/HLBSP02-C系列防爆防腐插接装置(ⅡC、ⅢC)

■ 型号含义



注: 63A。

注: 16A、32A。

■ 适用范围

1. I区、2区ⅡA~ⅡC类爆炸性气体环境, 和/或21区、22区爆炸性粉尘场所;
2. 强腐蚀气体环境;
3. 温度组别: T1~T6;
4. 户内、户外(IP66);
5. 用于化工、炼油、石油开采、海洋石油平台、油轮、军工等危险场所。



■ 产品特点





1. 高强度玻璃纤维不饱和聚酯树脂模压外壳, 具有抗静电、耐腐蚀、抗冲击、热稳定性好等性能, 外形美观;
2. 具有可靠的联锁功能, 即只有插座腔内的开关分断后插头才能拔出, 只有插头插入腔内, 开关才可闭合;
3. 插头接触性能可靠, 使用寿命长, 插座内的插套有一个弹性的百叶式簧套, 使插头既有自我清洁的特性, 又保证了小的接触电阻和低温升, 同时也将所要的插拔力降到了最低, 百叶式簧套的设计保证了插头和插座功能的正常发挥和永久的自清洁效果, 解决了插接装置在使用中受周围环境的影响(如湿度, 尘埃等), 确保了插接装置的电传输性能;
4. 插座设有挂锁, 不使用时可锁定, 插座无法打开。

■ 主要技术参数

防爆标志	防护等级	电缆入口 / 电缆外径(mm)	插头电缆外径(mm)	防腐等级
Ex db eb Ⅱ C T6/T5 Gb Ex tb Ⅲ C T80°CDb	IP65	16A: M25 × 1.5 / φ 8~φ 14	16A/3: φ 7 ~ φ 16 16A/4(5): φ 9 ~ φ 19	WF2
Ex db eb Ⅱ C T5/T4 Gb Ex tb Ⅲ C T80°CDb	IP65	32A: M40 × 1.5 / φ 15~φ 26	32A: φ 12 ~ φ 28	
Ex db eb Ⅱ C T5 Gb Ex tb Ⅲ C T80°CDb	IP66	63A: M50 × 1.5 / φ 19~φ 36	63A: φ 19 ~ φ 28	
Ex db eb Ⅱ C T4 Gb Ex tb Ⅲ C T80°CDb	IP66	125A: M63 × 1.5 / φ 37~φ 44	125A: φ 34 ~ φ 53	

*: 订购时需提出。

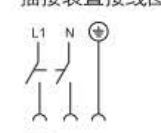
■ 产品图样(16A/3极)

HLBSP02-16/3	时钟h和电压
	 110~130V 1P+N+PE 黄色
	 200~250V 1P+N+PE 蓝色
	插接装置接线图(16A/3极)   1P+N+PE

■ 外形尺寸(16A/3极)

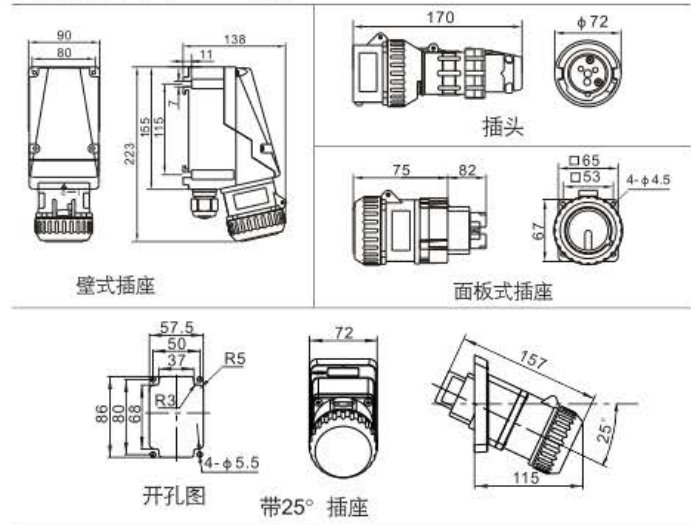







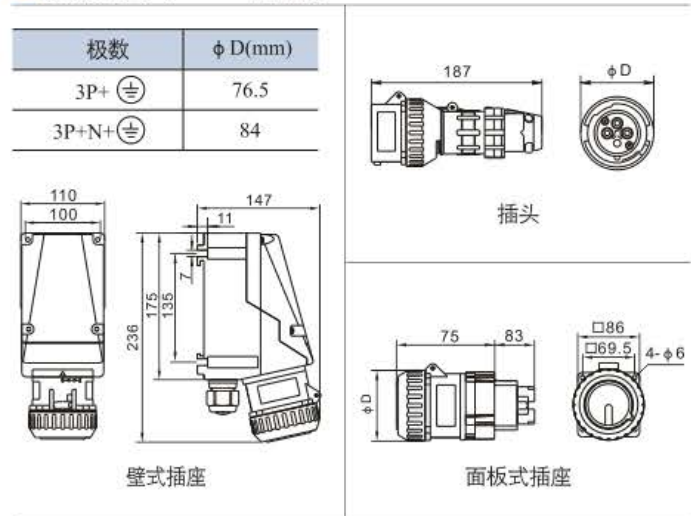

■ 产品图样(16A/4极)

HLBSP02-16/4	时钟h和电压
	 220~250V 3P+PE 蓝色
	 380~415V 3P+PE 红色
	 480~500V 3P+PE 黑色
	 600~690V 3P+PE 黑色

■ 外形尺寸[16A/4(5)极]



■ 产品图样(16A/5极)

HLBSP02-16/5	时钟h和电压
	 220~250V 3P+N+PE 蓝色
	 380~415V 3P+N+PE 红色
	 480~500V 3P+N+PE 黑色
	 600~690V 3P+N+PE 黑色

■ 插接装置接线图[16A/4(5)极]

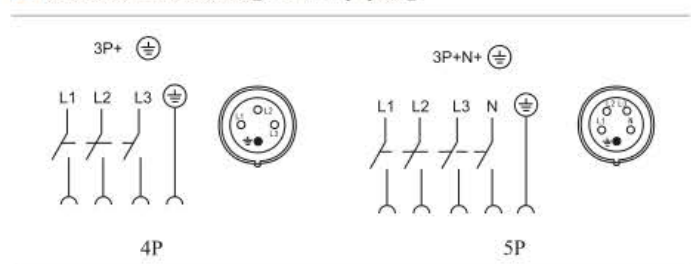

■ 产品图样(32A/4极)

HLBSP02-32/4	时钟h和电压
	220~250V 3P+PE 蓝色 h9
	380~415V 3P+PE 红色 h6
	480~500V 3P+PE 黑色 h7
	600~690V 3P+PE 黑色 h5

■ 产品图样(32A/5极)

HLBSP02-32/5	时钟h和电压
	220~250V 3P+N+PE 蓝色 h9
	380~415V 3P+N+PE 红色 h6
	480~500V 3P+N+PE 黑色 h7
	600~690V 3P+N+PE 黑色 h5

■ 外形尺寸及插接装置接线图[32A/4(5)极]

极数	φ D(mm)	插头	接线图
3P+⊕	95		
3P+N+⊕	100		

■ 产品图样(63A/4极)

BCZ8060-63/4	时钟h和电压
 <p>墙壁插座</p> <p>插头</p>	 220~250V  3P+PE 蓝色 h9
	 380~415V  3P+PE 红色 h6
	 480~500V  3P+PE 黑色 h7
	 600~690V  3P+PE 黑色 h5

■ 产品图样(63A/5极)

BCZ8060-63/5	时钟h和电压
 <p>墙壁插座</p> <p>插头</p>	 220~250V  3P+N+PE 蓝色 h9
	 380~415V  3P+N+PE 红色 h6
	 480~500V  3P+N+PE 黑色 h7
	 600~690V  3P+N+PE 黑色 h5

■ 插接装置接线图[63A/4(5)极]

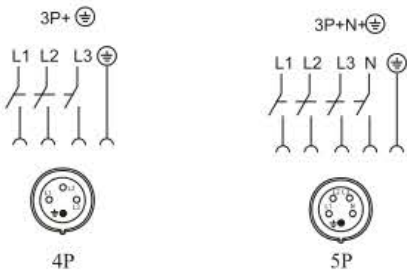

■ 外形尺寸[63A/4(5)极]

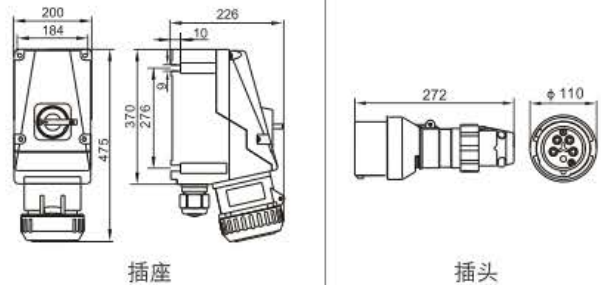

■ 产品图样[125A/4(5)极]

BCZ8060-125/4	时钟h和电压
 <p>墙壁插座</p> <p>插头</p>	 220~250V  3P+PE 蓝色 h9
	 380~415V  3P+PE 红色 h6
	 480~500V  3P+PE 黑色 h7
	 600~690V  3P+PE 黑色 h5
BCZ8060-125/5	时钟h和电压
 220/380V  240/450V 3P+N+PE 红色 h6	

■ 插接装置接线图[125A/4(5)极]

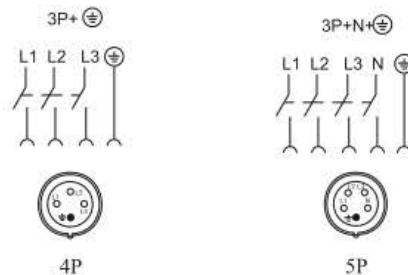

■ 外形尺寸[125A-4(5)极]

